

AV Center

Wirelessly Connected Car Stereo
1-DIN Car Stereo w/ Wireless Apple CarPlay®

MP3/MP4/USB

Built-in AM/FM & Bluetooth

Supports Apple CarPlay®



POWER ACOUSTIK®

Headquarters
1550 South Maple Ave. Montebello CA, 90640

Technical Support: (800) 832-4647.
Email: tech-support@poweracoustik.com



www.PowerAcoustik.com



INTRODUCTION

Safety Warning and Considerations

- Clean only with a dry cloth or other similar materials.
- Install your product in a dry location that does not interfere with your vehicle's equipment.
- Do not block any ventilation openings when installing this product.
- Do not mount in the engine compartment of your vehicle or any hot surfaces.
- Securely mount the product so that it does not come loose in the event of a collision or as a result of repeated vibrations that might occur during regular operation.
- Installation of the apparatus must be done with great care to prevent damage to your vehicle's fuel lines, power, and electrical wiring, hydraulic brake lines, and other systems. If possible, always visit your nearest Power Acoustik dealer to perform the installation.
- Do not run any wiring outside or underneath the vehicle. Keep all wires inside the car.
- Take the necessary precautions when making connections to the vehicle's battery to avoid any potential shock.
- Protect all system wires from sharp edges by carefully routing them, always use rubber grommets to protect wiring and cables whenever installing them through metal opening.
- Secure all wiring using cable ties or wire clamps to protect them from moving parts and sharp edges.
- Refer all servicing to qualified service professionals. Service is required when the head unit has been damaged. Such as the power input terminals are damaged, liquid has been spilled, or objects have fallen into the apparatus, the apparatus has been exposed to rain or moisture, does not operate normally, or has been dropped.
- Fused shall be replaced only with the correct type and fuse value, and only when the apparatus is powered off.
- Exposure to high sound pressure levels may lead to permanent hearing loss. Take every precaution to protect your hearing.
- This product is designed specifically for use with 12V negative-ground systems only. Using this product in systems with positive ground and / or voltages other than 12V may damage the product and your system.

**LIMITED 90-DAY CONSUMER WARRANTY
 LIMITED ONE-YEAR CONSUMER WARRANTY WITH PURCHASE AND INSTALLATION BY A
 Power Acoustik AUTHORIZED DEALER**

Power Acoustik promises to the original purchaser, to repair or replace this product with a new or refurbished unit (at Power Acoustik's sole and absolute discretion) should it prove to be defective in workmanship or material under normal use, for a period of one-year from the date of purchase from the Power Acoustik authorized dealer, PROVIDED the product was purchased and installed by a Power Acoustik authorized dealer. During this one-year period, there will be no charge for product repair or replacement, PROVIDE the unit is returned to Power Acoustik, return shipping pre-paid, along with the required proof of installation, the bill of sale or other dated proof of purchase, and the consumer's contact information.

If the unit is installed by anyone other than a Power Acoustik authorized dealer, the warranty period will be 90-days from the date of purchase. This warranty is non-transferable and does not apply to any unit that has been modified or used in a manner contrary to its intended purpose, and does not cover damage to the unit caused by installation or removal of the unit. During this 90-day period, there will be no charge for the repair or replacement PROVIDED the unit is returned to Power Acoustik, return shipping prepaid, along with the bill of sale or other dated proof of purchase and the consumer's contact information.

This warranty is void if the product has been damaged by accident or unreasonable use, neglect, improper service or other causes not arising out of defects in materials or construction. This warranty does not cover the elimination of externally generated static or noise, or the correction of antenna problems or weak reception, damage to speakers, accessories, electrical systems, cosmetic damage or damage due to negligence, misuse, failure to follow operating instructions, accidental spills or customer applied cleaners, damage due to environmental causes such as floods, airborne fallout, chemicals, salt, hail, lightning or extreme temperatures, damage due to accidents, road hazards, fire, theft, loss or vandalism, damage due to improper connection to equipment of another manufacturer, modification of existing equipment, or Product which has been opened or tampered for any reason. Units which are found to be damaged by abuse resulting in thermally damaged voice coils are not covered by this warranty but may be replaced at the absolute and sole discretion of Power Acoustik. Unit must be returned to Power Acoustik, postage pre-paid, with bill of sale or other dated proof of purchase bearing the following information: consumer's name, telephone number, and address, authorized dealer's name and address, and product description. Please contact Power Acoustik warranty office at 800-832-4647 or repairs@poweracoustik.com to obtain a Return Authorization number prior to shipping the product.

Note: This warranty does not cover labor costs for the removal and reinstallation of the unit. IN ORDER FOR THE ONE-YEAR WARRANTY TO BE VALID, YOUR UNIT MUST BE SHIPPED WITH PROOF OF INSTALLATION BY A POWER ACOUSTIK AUTHORIZED DEALER. ALL UNITS RECEIVED BY POWER ACOUSTIK FOR WARRANTY REPAIR WITHOUT PROOF OF POWER ACOUSTIK AUTHORIZED DEALER INSTALLATION AND PURCHASE WILL BE COVERED BY THE LIMITED 1 YEAR WARRANTY.

BY PURCHASING THIS PRODUCT, ALL WARRANTIES INCLUDING BUT NOT LIMITED TO EXPRESS WARRANTY, IMPLIED WARRANTY, WARRANTY OF MERCHANTABILITY, FITNESS FOR PARTICULAR PURPOSE, AND WARRANTY OF NON-INFRINGEMENT OF INTELLECTUAL PROPERTY ARE EXPRESSLY EXCLUDED TO THE MAXIMUM EXTENT ALLOWED BY LAW, AND POWER ACOUSTIK NEITHER ASSUMES NOR AUTHORIZES ANY PERSON TO ASSUME FOR IT ANY LIABILITY IN CONNECTION WITH THE SALE OF THE PRODUCT. POWER ACOUSTIK HAS ABSOLUTELY NO LIABILITY FOR ANY AND ALL ACTS OF THIRD PARTIES INCLUDING ITS AUTHORIZED DEALERS OR INSTALLERS. BY PURCHASING THIS PRODUCT, THE CONSUMER AGREES AND CONSENTS THAT ALL DISPUTES BETWEEN THE CONSUMER AND POWER ACOUSTIK SHALL BE RESOLVED IN ACCORDANCE WITH CALIFORNIA LAWS IN LOS ANGELES COUNTY, CALIFORNIA. Some states do not allow limitation on how long an implied warranty lasts.

In such states, the limitation or exclusions of this Limited Warranty may not apply. Some states do not allow the exclusion or limitation of incidental or consequential damages. In such states, the exclusion or limitation of this Limited Warranty may not apply to you. This Limited Warranty gives you specific legal rights, and you may have other rights which vary from state to state.

CONTENTS

Introduction	2
Wiring Connection	4
Installation & Accessories	5
Parking & Speaker connection	6
Pannel Function Introduction	7
Remote Control Introduction	8
Functions Applications	9
Main Menu	
Radio	
Bluetooth Phone	
Bluetooth Music	
External Play Device(USB Playback)	
Settings Operation	
Apple CarPlay™ – Connect Wirelessly or via USB	
Front Camera / Rear Camera	
Common Trouble-shooting	19
Specification	20
FCC Compliance	21
Warranty	22

Wiring:

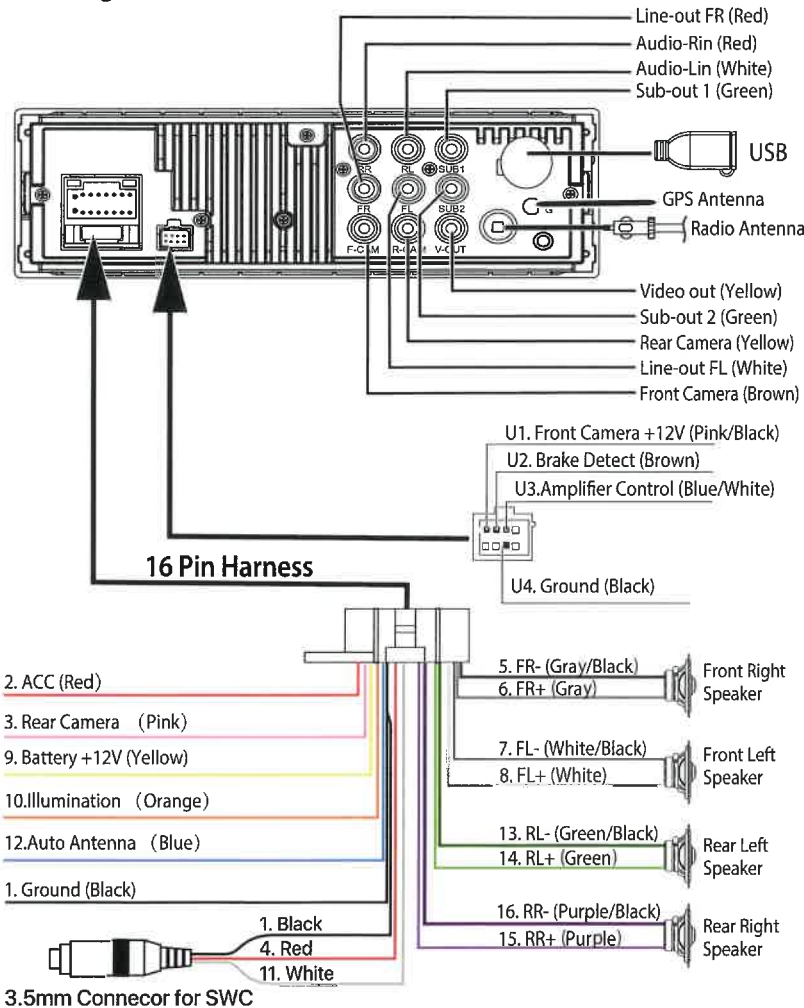

*To use the steering wheel control feature, you need an universal remote adapter (not supplied) matched your car.

Fuse: Max.15Ampere
Voltage: 12V DC; Negative Ground

FCC Compliance

This device complies with Part 15 of the FCC Rules. Operation is subject to the following two conditions:

- (1) this device may not cause harmful interference, and
- (2) this device must accept any interference received, including interference that may cause undesired operation.

Warning: Changes or modifications to this unit not expressly approved by the party responsible for compliance could void the user's authority to operate the equipment.

Note: This equipment has been tested and found to comply with the limits for a Class B digital device, pursuant to Part 15 of the FCC Rules. These limits are designed to provide reasonable protection against harmful interference in a residential installation.

This equipment generates, uses and can radiate radio frequency energy and, if not installed and used in accordance with the instructions, may cause harmful interference to radio communications.

However, there is no guarantee that interference will not occur in a particular installation. If this equipment does cause harmful interference to radio or television reception, which can be determined by turning the equipment off and on, the user is encouraged to try to correct the interference by one or more of the following measures:

- Reorient or relocate the receiving antenna.
- Increase the separation between the equipment and receiver.
- Connect the equipment into an outlet on a circuit different from that to which the receiver is connected.
- Consult your Power Acoustik dealer.

SPECIFICATION:

General

Power Supply	DC10~16 Volts
Grounding System	Negative Ground
Current Drain	1.5A(Max.)
RMS Power Output.....	4x17W/channel
Speaker Impedance.....	4~8ohms per channel
Frequency Response.....	20Hz~20KHz
Operating Temperature	-20~+60 °C
Dimensions	188mm(W)x135mm(D)x60mm(H)

TFT Display

TFT Screen size.....	6.5inch
Resolution.....	960x480 pixels

FM Radio

Frequency Range (USA).....	87.5~107.9MHz
Frequency Range (Europe)	87.5~108MHz
Usable Sensitivity (S/N=30dB).....	≤15dB
S/N Ratio.....	≥55dB
Stereo Separation.....	≥30dB

AM

Frequency Range (USA)	530~1710KHz
Frequency Range (Europe)	522~1620KHz
Usable Sensitivity(S/N=20dB)	≤40dB
S/N Ratio.....	≥45dB

Line-Out/Subwoofer Output

Maximum Output Level (10K ohms load).....	≥4V RMS
Subwoofer Output Level.....	≥4V RMS

INSTALLATION & ACCESSORIES

INSTALLATION

Mounting the Headunit: Typical DIN Mounting

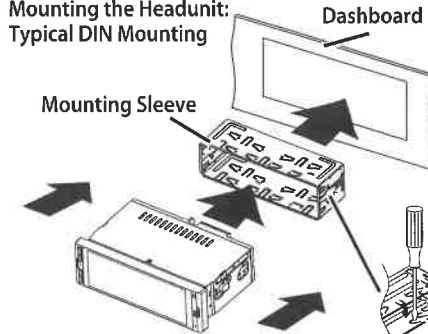

Step 1:
Insert the Mounting Sleeve into the installation kit or dashboard.

Step 2:
Bend multiple tabs around the mounting sleeve until the mounting sleeve is secure.

Step 3:
Connect all wiring harnesses and slide the headunit into the Mounting Sleeve until it clicks into place.

Sliding body chassis

UNINSTALLATION





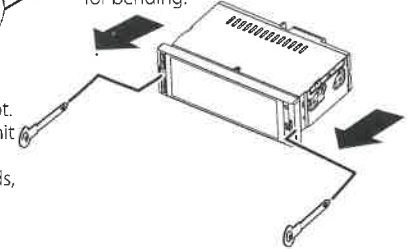

Insert the 2 release keys deeply into the slot. With the inserted keys to pull out the unit halfway. Pull the unit all the way with your hands, being carefully not to drop it.

Select the proper TAB for bending.

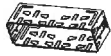

ACCESSORIES

Package contains the following for installation and operation of the unit.

(1) Mounting Sleeve	1		(5) Remote Control	1	
(2) Release Key	2				
(3) Wire Harness	1		(6) User Manual	1	
(4) 8 Pin Connector	1		(7) GPS Antenna	1	

PARKING & SPEAKER CONNECTIONS

Note: To watch video the parking wire should be connected the brake signal.

Parking wire

Note: The parking wire is connected with brake signal; for safety, the programs can be seen on the headunits touch screen.

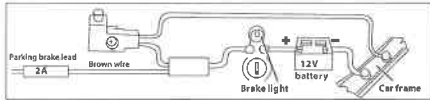

Connecting the reverse signal at taillight on the car (12V+ Required for Signal).

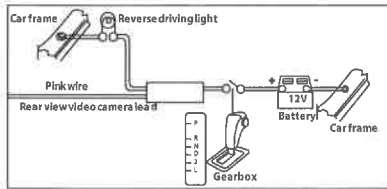

After connecting, when you start up the reverse gear, the unit will receive the picture from car rear view camera.

Speaker Connection

- We recommended using car speaker with minimum 40 Watt potential.
- Headunits potential power may result in damaging your OE speakers at higher volumes.
- Use 4Ω -8Ω (Ohm impedance) speakers only; using higher or lesser impedance may damage the headunit.
- Speaker cables and / or optional external power amplifiers must always be about 30cm away from the antenna and / or antenna extension parts.
- Do not connect the speaker leads of the power harness to battery; otherwise, the unit will be seriously damaged.
- Before connecting the speaker leads the harness to the speakers, check the speaker wiring in your car.

Connect the speakers according the following diagram, incorrect connections will damage the headunit or your vehicle's speakers.

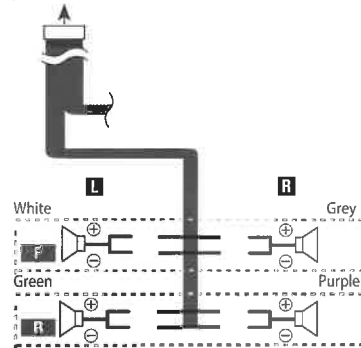

COMMON TROUBLE-SHOOTING

Problem	Cause	Correct action
Cannot power on	Check fuse	Replace fuse
	Other factors causing MPU to malfunction	Press RST button on the panel by penpoint, then, power on
After ignition switch off, setting information are lost	Change battery or fuse	Reset information and save
Poor performance of radio station	Weak signal	Move the car to another place, then try again
No Picture/Image	Other factors causing MPU to malfunction	Press RST button on the panel by penpoint, then, power on
Cannot watch video during driving	Video viewing is not allowed during driving	Park the car in, put the car in "P" position, pull up the hand brake, parking brake wire must be grounded.
Screen show overcurrent caution	Once the USB current is overload the maximum limit, the headunit will protect by itself.	Please pull out the USB and restart the headunit
Apple CarPlay will not start	Bad Lightning™ /USB cable Locked device Not charged CarPlay frozen	Replace the cable. Device needs to be unlocked. Device needs to be powered ON for Apple CarPlay™ to function. Allow it to charge and power on. Unplug the device, close all Apps and plug it in again.
Bluetooth is not connected	Not connecting to the device	Make sure the device is within range. Device's Bluetooth connection needs to be turned ON. Go to Setting>GeneralSetting>BT > BT Connection>Power ON. Pair and connect the device like new.

FUNCTIONS APPLICATION

5. Tap "Yes" to use wireless Apple CarPlay.



Or you can use your iPhone to search "CP-71W" and connect it. The screen will pop-up below notice, you can select to work with Apple



Once complete the connection, the Device list will be as below:



After finished the Pairing, the device list as below:

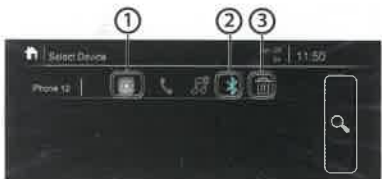

1. Tap to activate Apple CarPlay function.
2. Tap to activate Bluetooth Phone/Music function.
3. Tap to delete the current connected device.

Note: When the wireless connected, the iPhone's Wifi connection will be disconnected automatically.

Front Camera

There is a RCA socket for the Front camera video signal to display on the Head unit.

1. Connect a front Camera to the F-cam input terminal of the back side headunit.
2. Touch [F-Camera]
3. Displaying the picture from the front view camera



Rear view camera

To use a rear view camera, the REVERSE lead connection is required. For connecting a rear view camera.

Displaying the picture from the rear view camera

The rear view screen is displayed when you shift the gear to the reverse (R) position.



PANNEL FUNCTION INTRODUCTION



1 Power On/Off

- When the power is off, press to power on.
- When the unit is working, short pressing for Mute, press again for unmute.
- Pressing and hold to turn the source unit power off.

2 Siri Button (Voice Recognition)

- When the iPhone phone is connected, short press **Siri** button to start the voice control function.
- Press and hold to back the main menu.

3 Microphone

- Built-in Microphone.

4 Volume +

- Press and hold to increase the volume continuously.
- Short press to increase the volume by

5 Volume -

- Press and hold to decrease the volume continuously.
- Short press to decrease the volume by step.

6 Remote Sensor

- Receive the remote signal.

7 Type-C Port

- Fast charging port.

8 Reset:

If the unit or the connected unit fails to operate properly, the unit returns to factory settings when this button is pressed.

REMOTE CONTROL INTRODUCTION



- 1 **Power Button**
-Press to Power ON / OFF.
- 2 **BND / Button**
-[Radio], press repeatedly to select desired Band: FM1>FM2>FM3>AM1>AM2.
-[Bluetooth], press to answer the incoming call or redial out.
- 3 **Seek Buttons**
-[Radio] Press and hold to active manual seek, then press to step upward. Press previous button to step down.
Short press to start auto seek down.
-[USB Music] Press repeatedly to shift track previous for playback.
Press and hold to active fast rewind for playback.
-[Bluetooth Music] Press repeatedly to shift track Previous for playback.
- 4 **HOME Button**
-in operation, short press to back Main Menu.
- 5 **EQ/Loud Button**
-Short press to select desired preset EQs
EQ: Off>Soft Rock>Pop>Electric>Jazz>EQ Custom.
-Long press to select Loud is On / Off.
- 6 **1/▶| Button**
-[Radio] Press to select preset 1 radio station for broadcasting.
-[USB/BT Music] Press to Play or Pause.
- 7 **2 Button**
-[Radio] Press to select preset 2 radio station for broadcasting.

- 8 **4/RDM Button**
-[Radio] Press to select preset 4 radio station for broadcasting.
-[USB Music] Press to switch Random On / Off.
- 9 **5 Button**
-[Radio] Press to select preset 5 radio station for broadcasting.
- 10 **MOD/ Button**
-In any mode, short press to select desired mode.
-[Bluetooth], short press to hang-up the talking phone or reject the incoming call.
- 11 **Mute Button**
-Press to Mute or Un-mute.
- 12 **APS Button**
-[Radio] Short press to Pre-scan search, each scanned station will be play for 3 seconds.
Long press to Auto Search.
- 13 **VOL+ Button**
-Press to increase the Volume value.
- 14 **▶▶| Button**
-[Radio] Press and hold to active manual seek, then press to step upward. Press previous button to step down.
Press to auto seek up.
-[USB Music] Press repeatedly to shift track next for playback.
Press and hold to active fast forward playback.
-[Bluetooth Music] Press repeatedly to shift track next for playback.
Long press to re-dial the latest call log.
- 15 **DISP Button**
-[Video] Press to display the time information.
- 16 **VOL- Button**
-Press to decrease the Volume value.
- 17 **3/RPT Button**
-[Radio] Press to select preset 3 radio station for broadcasting.
-[USB/SD Music] Press to select Repeat function.
- 18 **6 Button**
-[Radio] Press to select preset 6 radio station for broadcasting.
- 19 **7/*/# Button**
1-6, 8,9,0 Button
-[BT Phone] Press to input the desired number to make a phone call.

FUNCTIONS APPLICATION

You can use Apps of connected iPhone. The items displayed and the language used on the screen differ among the connected devices. To enter the Apple CarPlay mode, touch Apple CarPlay icon on the Home selection screen.



- ① **Application keys**
Start the application.
- ② **CarPlay icon**
Display the home screen of Apple CarPlay. Touch and hold to active *Siri*.
- ③ **Home**
Exit the Apple CarPlay screen and displays Home screen.
* The icon design may change depending on the iOS version.

How to connect Wireless Apple CarPlay

Starting procedure of using Wirelessly Apple CarPlay

Before using Apple CarPlay wirelessly, turn on the Bluetooth function on the iPhone.

1. On the Main menu tap the icon access to Device Link interface.



2. Touch "SEARCH" button to search available devices, then follow the pop-up notice for operation:



The available devices will be listed as below:



3. Select the desired iPhone for connection, both the headunit / iPhone will pop-up the pairing code, confirm to connection.



4. Headunit will pop-up CarPlay connection request:



GPS Connection Status



Wallpapers Setting

Choose the required wallpaper, touch "wallpaper setting" icon to enter the setting interface.



Serial/Version

Show the software / hardware information.



Note: How to Update the software.

Put the software into the USB, then plug the USB to the headunit, select Setting>General>Serial&Version, touch "Update". The headunit will update the software accordingly.

Reset Factory Data

Once selected, the unit will prompt to confirm reset to factory settings. Once confirmed the system will automatically reboot.



Bluetooth Setting



Apple CarPlay™ – Connect Wirelessly or via USB:

A smarter, safer and more fun way to use your iPhone in the car. Apple CarPlay gives iPhone users an intuitive way to make calls, use Maps, and listen to music with just a word or a touch.

Compatible iPhone models
For details about compatibility of iPhone models, refer to the following website.
<https://www.apple.com/ios/carplay>

WARNING

Certain uses of the iPhone may not be legal while driving in your jurisdiction, so you must be aware of and obey any such restrictions. If in doubt as to a particular function, only perform it while the car is parked. No feature should be used unless it is safe to do so under the driving conditions you are experiencing.

Notes on using Apple CarPlay

- iPhone with iOS 7.1 or later is required. Update to the latest iOS version before use.
- Apple CarPlay can be used on iPhone 5 or later.
- For details on compatible models, refer to the compatibility list on the support site on the back cover.
- For details about Apple CarPlay, refer to the manual supplied with your iPhone, or visit the website of Apple CarPlay.
- Since the GPS on your iPhone is used, place your iPhone where it can easily receive a GPS signal.

- You can use Siri function by touching  button once Apple CarPlay is activated.
- The Bluetooth connection with the Apple CarPlay compatible device will be terminated automatically if Apple CarPlay is turned on.
- Hands-free phoning via Bluetooth wireless technology is not available while Apple CarPlay is on.

Starting procedure of using Apple CarPlay via USB

- 1 Connect an Apple CarPlay compatible device to this unit via USB.
- 2 Touch the Apple CarPlay icon.
The Apple CarPlay home screen appears.

Basic Operations

Main Menu

Please refer to the actual menu display for reference.

During initial power on, the unit will show the languages setting interface, select the required country and language, then press "✓" to enter the main menu.



Apple CarPlay :Shows Apple CarPlay interface (when the iPhone connected)

Radio : Shows the Radio interface.

BT Phone : Shows the Bluetooth Phone interface (when Bluetooth connected)

BT Music : Shows the Bluetooth Music interface (when Bluetooth connected)

USB : Shows the USB interface, enabling playback for compatible files.

F-Camera:View the Front Camera.

Device Link: Shows the DeviceLink interface.

Settings: Shows the Settings interface.

Radio

Touch "Radio" in the main menu to enter the AM/FM radio interface.



- 1 Home Button
•Press to return to HOME page.
- 2 << Button
•Short press to search backward for stations automatically.
•Long press to step downward.
- 3 FM BAND Button
•Switch between FM1/FM2/FM3.
- 4 AM BAND Button
•Switch between AM1/AM2.
- 5 >> Button
•Short press to search upward for stations automatically.
•Long press to step upward.
- 6 GOTO Button
•Press to POP-UP tuning input interface, input the frequency number directly.

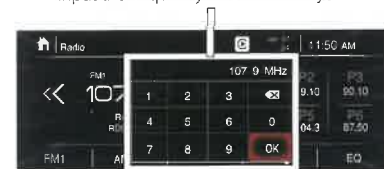

- 7 Preset Button
•Press to select preset stations to start playback.
- 8 Search Button
•Short touch to prescan searching, each scanned station will be played 10s.
•Long touch for auto searching.

FUNCTIONS APPLICATION

- EQ Button
•Press to enter EQ settings interface.

- RDS Information
•Display current station RDS information.

Note:

- RDS default is ON status.
- When receive the RDS information, will display on the screen.

Store a Station

- Tune radio to desired station.
- Touch and hold the one of the preset station for more than 3 seconds, then the preset button will be highlighted on the screen, and the preset station will be stored.

BT Phone

This unit allows for hands free calling, using your phone's Bluetooth connection to the unit, you'll be able to dial, answer, access phone book and playback music. Enter the Bluetooth interface using the BT Phone button.



- Keypad Button**
•Press to enter call mode.
- Contact Button**
•Press to show the phonebook connected phone.
- Recent Button**
•Press to show the call record, missed, received and dialed calls.
- BT Settings Button**
•Press to show the Bluetooth Settings interface.

Pair/Connect

Connect your phone to the unit using the below steps.

- Access the Bluetooth connection interface in your phone.
- Search for Bluetooth devices and will detect the headset "CP-71W". Then select to connect.
- The device will pop up the pairing code and click "Confirm" to complete the connection.



No Pair:

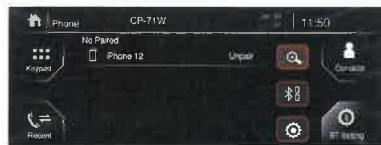

Paired:

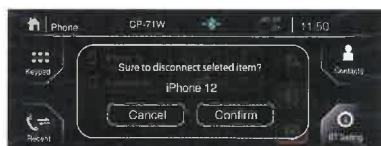

- :Search the available devices.
- :Manage the connected device.
- :Set auto answer and load phonebook.

FUNCTIONS APPLICATION

General Setting



Brightness

- :Adjust the screen's brightness from 0-5.

- Illumination Detect** :Select On / Off.
- Key LED**



Led Auto: Touch icon to select LED Auto or Manually change.

Led Color: When close to LED Auto change function, you can manually select the LED light color: **White/Red/ Yellow/Blue/Green/Purple/ Cyan.**

Radio Area



Radio Area : Choose the required radio region : **America / Europe / Eastern Europe/ Japan / Southeast Asia /Latin America / Asia/Australia.**

RDS

- :Select On / Off.

Rear Camera



Rear Camera View: Normal/Reverse

Parking Assist Guide: :Select On / Off.

Parking Assist Guide Adjustment:

Touch "to enter Parking Assist Guide Adjustment interface to show the belowscreen:

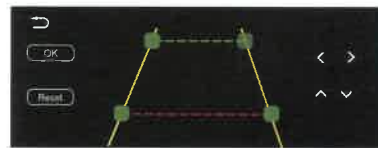

Select the adjust position and Touch to < / > / ^ / v /adjust. Touch "OK" to confirm. Touch "Reset" to resume the default Parking Assist Line.

Language

Touch the icon to enter language setting interface, select the required language.



WiFi Setup



WiFi Connection: :Select On / Off.
Device Name: CP-71W

FUNCTIONS APPLICATION

Settings Operation

Touch "  " icon from main menu to enter the settings interface.

Time Setting

Touch "Time" to enter time setting .
Up/down sliding can set Year/Month/Day /Hour/Minute Model.



Sound Setting

Touch "Sound Setting" to enter sound setting interface:



BEEP : Switch the Beep is On /Off.

Reverse Vol : Adjust the Vol 0-30.

Digital Equalizer:



◀▶ : Select desired equalizer: Off>Soft Rock>Pop>Electric>Jazz>EQ Custom

In Custom, can adjust the 10-band frequency gain -6 + +6.

 : Reset to default settings.

Fader / Balance:



LOUD: Switch the Loud is On /Off.

Fader : Adjust the fader F12-R12.

Balance : Adjust the balance L12-R12.

 : Reset to default settings.

Subwoofer:



Subwoofer :Switch the Subwoofer is On /Off.

Subwoofer Frequency :Select 50Hz>80Hz>120Hz>160Hz

Subwoofer Level : Adjust the value -10~+10.

Default Volume:



Main / Bluetooth Talking / Navigation / Voice default Volume:

You can set the default volume from 0 to 50.

FUNCTIONS APPLICATION

Receive an incoming call

If the Phone is connected with the source unit via Bluetooth, when an incoming call, below screen will be shown:



Press  to answer the incoming call.

Press  to reject the incoming call.

Note : You can also manage calls through your phone.

Calling Record

Check for dialed/answered/missed calls history. Touch icon  to enter calling record interface:



 : Delete desired call logs.

Phone Book





When your phone and unit are paired, the unit can automatically reach contacts from your phone and store them within the unit.(selected phones only)

 : Delete desired contact information.

Dial

Once the phone and unit are connected successfully, you'll be able to make calls from the unit. Touch  to make a call.



1. Touch the  icon to enter keypad screen.
2. Using the keypad, touch 0-9,*,#, enter the phone number you wish to dial. If you input an incorrect number, touch the  icon on the keypad to delete the incorrect number.
3. Once the correct number appears on the screen, touch the  icon. To go to dialing interface.

4. To end the call, touch the icon  on the screen.



- 1 **Switch Button** 
 - Press to switch call audio to phone or AV receiver.
- 2 **Keypad Button** 
 - Press to show the keyboard.
- 3 **Mute Microphone Button** 
 - Press to Microphone Mute or Un-Mute.
- 4 **Hang-up Button** 
 - Press to hang-up the calling.

FUNCTIONS APPLICATION

BT Setup



BT On /OFF, Power On or Off BT function.

Auto Answer On /OFF, incoming call auto answer.

Auto Load Phonebook, On /OFF, when connect phone auto load phonebook on or off.

Load Phonebook, Manually load phone book.

Bluetooth Music Playback

Touch to enter music interface.



1. Play previous song.
2. Play/pause current song.
3. Play next song.
4. EQ settings

Note :When you did not connect the Bluetooth device, the display will like below:



Note :Next / Previous / Play buttons are disable.

External Play Device-USB

Plug the USB and touch the USB icon to enter the USB playback mode. The source unit default the play the Audio in the USB device.



- 1 **File List** Button
-Press to enter file list menu, you can select Music/ Picture / Video for playback.
- 2 **Previous** Button
-Short press: Play previous song/ media.
-Long press: Fast reverse.
- 3 **Play** / **Pause** Button
-Press to Play or Pause current song/me-
- 4 **Next** Button
-Short press: Play next song/ media.
-Long press: Fast forward
- 5 **Repeat** Button
-Press to select Repeat All > Repeat 1 > Repeat Off.
- 6 **Shuffle** Button
-Press to select Shuffle playback on/off.
- 7 **EQ** Button
-Press to enter EQ settings.

File List browsing

Touch to browse the folder and file list of the USB device. You can select the multi-media type (Music /Picture/Video)



FUNCTIONS APPLICATION

Picture Playback



- 1 **File List** Button
-Press to enter file list menu, you can select Music/ Picture / Video for playback.
- 2 **Previous** Button
-Play previous picture.
- 3 **Play** / **Pause** Button
-Press to Play or Pause picture playback.
- 4 **Next** Button
-Play next picture.
- 5 **Rotate** Button
-Press to rotate the picture.
- 6 **Zoom out** Button
-Press to zoom out the picture.
- 7 **Zoom in** Button
-Press to zoom in the picture.



1. Return to playing previous file.
2. Select Picture files.
3. Select Music files.
4. Select Video files.

Video Playback



- 1 **File List** Button
-Press to enter file list menu, you can select Music/ Picture / Video for playback.
- 2 **Play** / **Pause** Button
-Press to Play or Pause current song/media.
- 3 **Repeat** Button
-Press to select Repeat All > Repeat 1 > Repeat Off.
- 4 **Shuffle** Button
-Press to select Shuffle playback on/off.
- 5 **Previous** Button
-Short press: Play previous video.
-Long press: Fast reverse.
- 6 **Next** Button
-Short press: Play next video.
-Long press: Fast forward